



**SOTTOSTAZIONI  
PER TELERISCALDAMENTO**  
DISTRICT HEATING SUBSTATIONS

GENERAL INFORMATION.....	2
Before installing .....	2
Materials and PED (2014/68/EU) Standards.....	3
SKID-TYPE DISTRICT HEATING SUBSTATIONS .....	4
Technical Features .....	4
SKID-TYPE SUBSTATION FOR HEATING USE ONLY.....	5
Hydraulic Diagram .....	6
SKID-TYPE SUBSTATION FOR HEATING AND DOMESTIC HOT-WATER PRODUCTION (with heat exchangers in parallel configuration) .....	7
Hydraulic Diagram .....	8
WALL-MOUNTED DISTRICT HEATING SUBSTATIONS.....	9
Technical Features .....	9
WALL-MOUNTED SUBSTATION FOR HEATING USE ONLY.....	10
Capacities and Dimensions.....	10
Hydraulic Diagram .....	11
WALL-MOUNTED SUBSTATION FOR HEATING AND DOMESTIC HOT-WATER PRODUCTION (with heat exchangers in parallel configuration) .....	12
Capacities and Dimensions.....	12
Hydraulic Diagram .....	13
WALL-MOUNTED SUBSTATION FOR HEATING AND DOMESTIC HOT WATER PRODUCTION (with heat exchangers in series configuration) .....	14
Capacities and Dimensions.....	14
Hydraulic Diagram .....	15
EXAMPLES OF SYSTEM LAYOUTS .....	16
LEGEND.....	16
DIAGRAM No. 1 .....	17
DIAGRAM No. 2 .....	17
DIAGRAM No. 3 .....	17
DIAGRAM No. 4 .....	18
DIAGRAM No. 5 .....	18
DIAGRAM No. 6 .....	18
DIAGRAM No. 7 .....	19

This document was created by the TECHNO SYSTEM Technical Office.

All rights reserved.

This document may not be reproduced in whole or in part without explicit written authorization by Techno System.

Techno System also reserves the right to modify the technical features and construction data of any product referred to herein at any time and without notice.



# GENERAL INFORMATION

TECHNO SYSTEM, a long-time leader in the district heating sector, builds skid-type substations (for medium and high capacity applications) complete with all the components needed for ensuring safety and for heat measurement and regulation as well as fittings for remote management. The substations are compact, can be completely dismantled, and can be installed even in small or difficult-to-access spaces.

The TECHNO SYSTEM district heating substations are supplied as pre-assembled, pre-cabled units that interface with the vector fluid delivery system (superheated or hot water) distributed by the energy production and/or supply companies to permit the user system – which operates at a lower temperature and pressure – to draw off the quantity of energy (heat) needed for heating and/or production of domestic hot water.

The district heating substation is a thermal exchange system comprising plate heat exchangers supplied by superheated or hot water for heating via radiators, fan coils, floor panels, etc., and/or for production of domestic hot water (DHW).

The heat exchangers are the TECHNO SYSTEM plate type, correctly dimensioned in accordance with project data and technical specifications. The electrical panel supplied with the substation is the standard TECHNO SYSTEM panel for DHS substations, featuring small size and full conformity with pertinent laws, standards, and regulations.

The TECHNO SYSTEM substations are pre-assembled and tested at our plant and can be supplied complete with insulation on the piping and heat exchangers.

The overall dimensions of the substations reflect the principles of maximum compactness typical of all TECHNO SYSTEM DHS substations. Any special adaptations to the substations are subject to separate estimate.

For building its DHS substations, TECHNO SYSTEMS uses only materials conforming to the requirements of the Pressure Equipment Directive ("PED Directive") – 2014/68/EU - and in compliance with the provisions of the Italian "Raccolta R" Edition 2009. The procedures and welding equipment used are DNV-qualified in accordance with EN 15614 and EN ISO 9606-1.

Where applicable, x-ray inspection of the piping welds is conducted in accordance with TECHNO SYSTEM standard procedures: 10% of the welded joints on category PED I, II, III, and IV substations are inspected, while no x-ray inspections are called for in the case of substations covered by Art. 3 § 3, which are also welded in accordance with EN 15614 and EN ISO 9606-1 standards.

The construction materials and production and testing methods used for building, testing, and outfitting the TECHNO SYSTEM substations (carrying ISO 9001-2015 and PED certification issued by DNV) all meet the standards set by the PED Directive. Each substation is supplied complete with statement of PED compliance.

In the wall-mounted DHS substations, the heat exchangers (in series or in parallel) are inserted in a load-bearing structure in hot-galvanized sheet with jacket (for the wall-hung version) or with epoxy-finished sheet-metal cornice (for the recessed version).

In the version featuring parallel exchangers, heating may operate simultaneously with DHW production, while DHW takes priority over heating in the version with series-mounted exchangers.

In the skid-type DHS substations, the heat exchangers are installed on a load-bearing carbon-steel base with singly-adjustable feet.

All the TECHNO SYSTEM district heating substations are equipped with an electrical control panel featuring a customizable PID (Proportional Integral Derivative) programmable logic digital controller with the most widely-used combinations pre-programmed.

## **Before installing**

Since there do not exist any technical standards making explicit reference to particular sites in which to install the substation for safety reasons, it is the responsibility of the system designer and/or installer to select the most suitable location for installation.

It is nevertheless prudent to not install the substation in direct contact with walls and/or other equipment installed in the "boiler room" in order to guarantee the best possible access in view of future routine and extraordinary maintenance operations.

Insofar as concerns the electrical supply system, refer to Italian Law no. 46/90 of March 1990 and to the pertinent CEI (IEC) standards.

Also remember that this type of heat generator is subject to the provisions of Italian Presidential Decree no. 412/93 concerning energy consumption for thermal uses in buildings.

All the pre-assembled substations built by TECHNO SYSTEM comply with the Pressure Equipment (PED) 97/23/EC, Low Voltage 73/23/EC, and Electromagnetic Compatibility 89/336/EC Directives, are supplied complete with all relevant documentation (Statement of PED Compliance, CE mark, use and maintenance manuals) called for by applicable laws, regulations, and standards, and are fully compliant with the prescriptions of said documents. All the pre-assembled substations built by TECHNO SYSTEM are constructed in conformity with the provisions of the Italian "Raccolta R" Edition 2009.

### **Materials and PED (2014/68/EU) Standards**

Following the entry into force of the Pressure Equipment Directive (PED – 2014/68/EU), TECHNO SYSTEM accelerated its ongoing quest for quality at all levels, to ensure full compliance with the Directive of all the models of TECHNO SYSTEM heat exchangers.

For the company, this step entailed obtaining certification of its Quality System certification and, at the same time, Form H and H1 PED certification.

The ensuing comprehensive revision of heat exchanger design and construction entailed redefinition and consequent improvement of all the safety and quality parameters, through use of materials with excellent mechanical properties.

# SKID-TYPE DISTRICT HEATING SUBSTATIONS

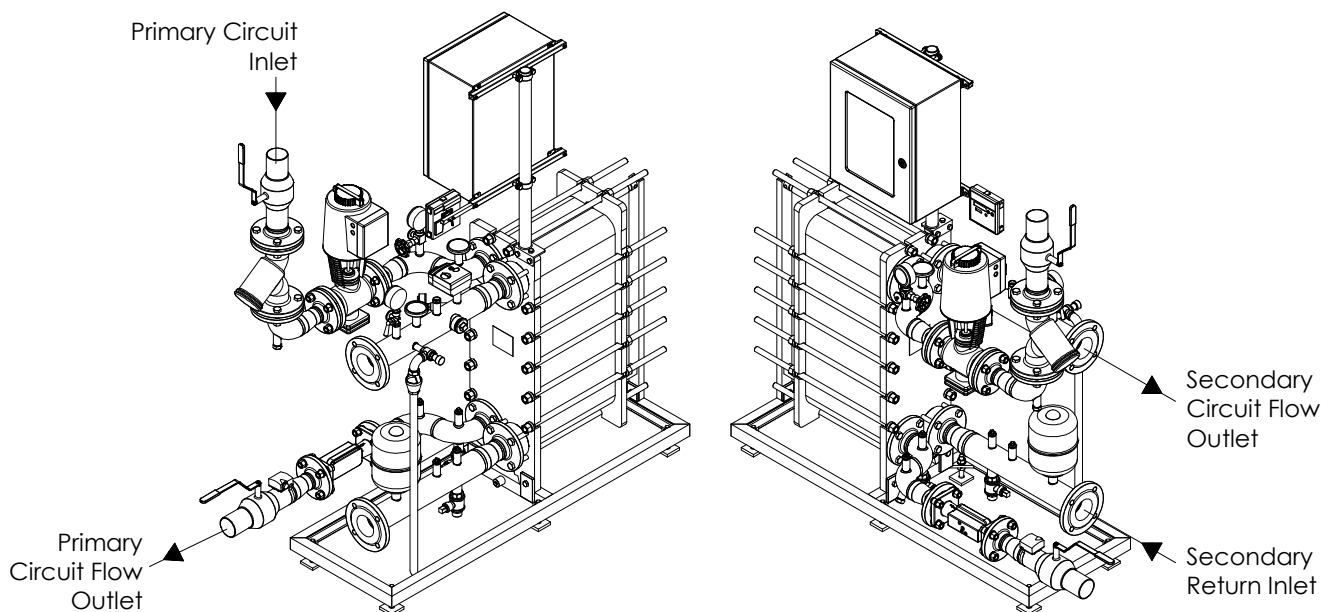

## **Technical Features**

- Maximum operating pressure DHS network 16 bar (optional PN25)
- Maximum operating pressure Heating side according to demand (max 8 bar)
- Maximum operating pressure DHW side 6 bar (where applicable)
- Maximum differential pressure on primary side 16 bar
- Minimum differential pressure on primary side close to substation 2 bar
- Maximum pressure drop on primary side 1 bar

Test pressure (differential) 1.43 times design pressure.

Protection Class IP54

Electrical supply voltage 230 V (optional 380 V)

Electrical supply frequency 50 Hz

The district heating substation is a fully pre-assembled, pre-cabled unit for heat transmission, featuring high yield and maximum operating safety. The base is built of steel sections which house:

- **Inspectable plate heat exchangers** (corrugated or smooth plates) **or braze welded heat exchangers**
- **Safety accessories:**
  - Safety valves, ISPEL certified (PED)
  - Expansion tank
- **Monitoring accessories:**
  - Pressure gauges
  - Thermometers
  - Immersion sensors
- **Protection accessories:**
  - Safety thermostats
  - Temperature-control thermostat (for hot water) or regulation and safety dual thermostat (for superheated water)
- **Control accessories:**
  - Two-way seated poppet valves
  - Electrical servo control for the above-mentioned valves
- **Automatic control accessories:**
  - Thermal regulation station for monitoring temperatures at various points and programming and defining parameters for the physical and electrical values to be managed.
- **Main electrical control panel**

On request, the skid-type district heating substations may be supplied fully insulated (exchanger and piping) or partially insulated (exchanger only or piping only).

N.B. Substations of this type may also be constructed for domestic hot water production alone. Such a version does not include the electrical panel, thermal regulation unit, or the external sensor. The off-site elements (as shown in the diagram below) must be connected to the thermal regulation panel of another substation designed for heating use only.

## SKID-TYPE SUBSTATION FOR HEATING USE ONLY

This type of substation is suitable for **high and medium capacity** systems supplied by **superheated water** or **hot water**. It is designed for **heating use only** and can be equipped with the SIEMENS RVD (or similar) controller or with the TECHNO SYSTEM TSRE 010 temperature-control system.

These substations integrate perfectly with systems for instantaneous production of domestic hot water with accumulation tanks, boilers, solar panels, and for pool heating systems, for example through application of specific modules units produced by TECHNO SYSTEM (refer to the examples included as attachments in this folder).

With this type of substation, users can:

- directly set the heating set-point using easy-access dedicated pushbuttons. (TSRE 010)
- manage heating independently, with separate onboard timers and weekly programs (TSRE 010)
- manage heating by external thermostat/timer-thermostat or on the basis of a weekly schedule programmed in the controller (on/off settings at half-hour intervals) (TSRE 010)
- set SUMMER or WINTER parameters (heating deactivated in SUMMER mode)
- manage heating temperature by the fixed-point or climate-curve method
- lock the heating-side set-point for systems serving floor panels (TSRE 010)
- set an ANTI-SCUFF cycle for the HEATING side pump (if installed) when system is in SUMMER mode
- set an ANTIFREEZE cycle with minimum threshold
- maintain temperature in the primary circuit via hydraulic bypass (with ball valve) or managed by the regulator (with times, intervals, and quantities set via the onboard calendar) (TSRE 010)
- connect a safety thermostat on the heating side (for floor-panel systems) featuring cut-in signal (by acoustic alarm and display message)
- signal sensor malfunction (by acoustic alarm and display message) (TSRE 010)
- signal excessive pressure in the heating circuit by acoustic alarm and display message and signal low water level in the heating circuit (and shutdown of the heating side pump, if applicable) by acoustic alarm and display message (TSRE 010)
- reset the values to factory defaults.

Additionally, this type of substation is prepared for installing devices for:

- limiting the flow rate on the DHS side
- limiting the return temperature on the DHS side, with sensor malfunction signal (by acoustic alarm and display message)
- remote reading of the thermal energy meter
- remote control
- managing a GSM or PSTN modem connection, which permits sending SMSs or e-mails for notifying alarms or malfunctions (TSRE 010).

Heating Capacity (kW)	Design Temperature (°C)	Overall dimensions (mm) Length x Height x Width	Connections on Primary Side	Connections on Secondary Side	Empty Weight (kg)
200	100	1390x1830x500	DN40	DN50	250
400	100	1560x1870x560	DN50	DN65	400
600	100	1770x1870x610	DN65	DN80	450
800	100	1730x1870x615	DN80	DN100	500
1000	100	1935x1890x1000	DN80	DN100	800
200	140	1160x1680x500	DN25	DN50	200
400	140	1405x1870x550	DN40	DN65	350
600	140	1520x1870x600	DN50	DN80	400
800	140	1780x1870x600	DN50	DN100	450
1000	140	1915x1840x1000	DN65	DN100	750

**NOTE: each substation is dimensioned on the basis of the pressure on the two circuits, the thermal head, and/or the heating capacity requested by the customer. For this reason, the overall dimensions of the substations are subject to change, case by case; the maximum measurements are suggested by the above table (calculation of table values is based on TECHNO SYSTEM standard parameters). Wall-mounted substations are available for heating capacities equal to or less than 150 kW.**





## **SKID-TYPE SUBSTATION FOR HEATING AND DOMESTIC HOT-WATER PRODUCTION (with heat exchangers in parallel configuration)**

---

This type of substation is suitable for **high and medium capacity** systems, supplied by **superheated water** or **hot water**, for **heating** and **production of domestic hot water**.

This type of substation is recommended for systems requiring separate and independent management of the heating and domestic hot water circuits.

These skid-type substations can be equipped with the SIEMENS RVD (or similar) controller or with the TECHNO SYSTEM TSRE 010 temperature-control system.

With this type of substation, users can:

- directly set the heating set-point and the DHW set-point using easy-access dedicated pushbuttons. (TSRE 010)
- manage heating and DHW production independently, with separate onboard timers and weekly programs.
- manage heating by external thermostat/timer-thermostat or on the basis of a weekly schedule programmed in the controller (on/off settings at half-hour intervals). (TSRE 010)
- set SUMMER or WINTER parameters (DHW only activated in SUMMER mode, DHW and heating activated in WINTER mode).
- manage heating temperature by the fixed-point or climate-curve method.
- set the set-points for heating, DHW, and recirculation (if applicable) independently.
- with the special Economy function, give precedence to DHW over HEATING. (TSRE 010)
- lock the heating-side set-point for systems serving floor panels. (TSRE 010)
- set an ANTI-SCUFF cycle for the HEATING side pump (if installed) when system is in SUMMER mode.
- set an ANTIFREEZE cycle with minimum threshold.
- maintain temperature in the primary circuit via hydraulic bypass (with ball valve) or managed by the regulator (with times, intervals, and quantities set via the onboard calendar). (TSRE 010)
- connect a safety thermostat on the heating side (for floor-panel systems) featuring cut-in signal (by acoustic alarm and display message).
- connect a safety thermostat on the DHW side (for protection against scalding) featuring cut-in signal (by acoustic alarm and display message).
- signal sensor malfunction (by acoustic alarm and display message). (TSRE 010)
- signal excessive pressure in the heating circuit by acoustic alarm and display message and signal low water level in the heating circuit (and shutdown of the heating side pump, if applicable) by acoustic alarm and display message). (TSRE 010)
- reset the values to factory defaults.
- integrate into other systems with accumulators, traditional boilers, and solar panels.

Additionally, this type of substation is prepared for installing devices for:

- managing recirculation via PID with set-point independent of DHW.
- managing an ANTI-LEGIONELLA thermal disinfection cycle via onboard calendar (the system must comprise recirculation).
- limiting the flow rate on the DHS side.
- limiting the return temperature on the DHS side, with sensor malfunction signal (by acoustic alarm and display message).
- remote reading of the thermal energy meter.
- remote control.
- managing a GSM or PSTN modem connection, which permits sending SMSs or e-mails for notifying alarms or malfunctions.

**Note: each substation is dimensioned on the basis of the pressure on the two circuits, the thermal head, and/or the heating capacity requested by the customer. For this reason, the overall dimensions of the substations are subject to change, case by case.**

## Hydraulic Diagram

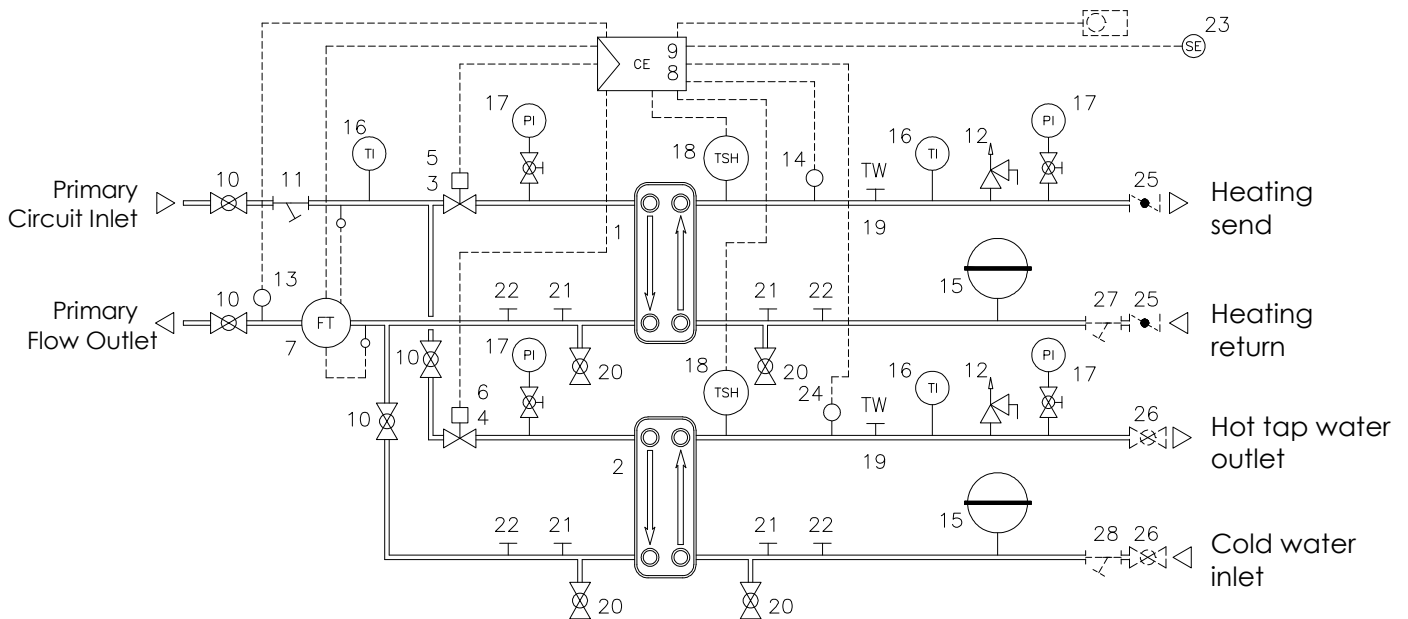

### Suggested diagram for district heating units working with hot water

For district heating units working with superheated water Techno System suggests using a single substation and an additional TS Module for tap water production (see diagrams at p. 17), in order to avoid encrustation problems.

#### COMPONENTS

- 1 Plate heat exchanger for HEATING
- 2 Plate heat exchanger for DHW
- 3 Servo-controlled valve for HEATING
- 4 Servo-controlled valve for DHW
- 5 Servomotor for HEATING
- 6 Servomotor for DHW
- 7 Thermal energy meter
- 8 Controller
- 9 Electrical panel
- 10 On/off ball valve on PRIMARY side
- 11 PRIMARY side filter
- 12 Safety valve
- 13 Temperature sensor on PRIMARY side
- 14 Temperature sensor on HEATING side
- 15 Expansion tank
- 16 Thermometer
- 17 Pressure gauge + 3-way valve, pressure gauge housing
- 18 Thermostat (dual thermostat for superheated water)
- 19 ISPEL thermometer well
- 20 Drain valve
- 21 Fitting for thermometer
- 22 Fitting for pressure gauge
- 23 External sensor
- 24 Temperature sensor on DHW side

#### OPTIONALS

##### ON/OFF VALVE SET

- 25 On/off butterfly valve, HEATING side
- 26 On/off butterfly valve, DHW side

##### MISCELLANEOUS

- 27 Filter, HEATING side
- 28 Filter, DHW side

# WALL-MOUNTED DISTRICT HEATING SUBSTATIONS

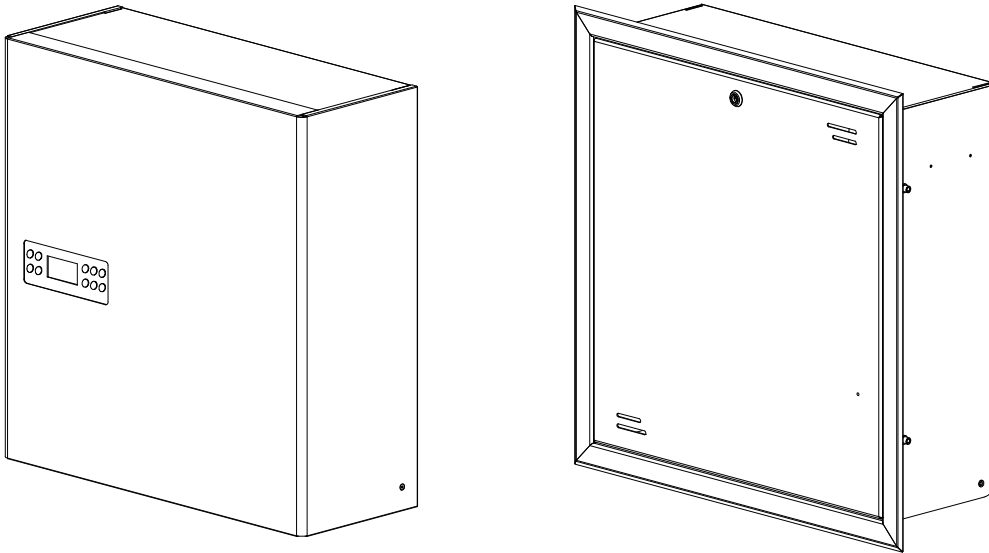

## **Technical Features**

Maximum operating pressure DHS network 16 bar (optional PN25)  
Maximum operating pressure Heating side 2.7 bar  
Maximum operating pressure DHW side 6 bar (where applicable)  
Maximum differential pressure on primary side 12 bar (for some models optional 3.5 bar)  
Minimum differential pressure on primary side close to substation 2 bar  
Maximum pressure drop on primary side 1 bar

Test pressure (differential) 1.43 times design pressure.  
Minimum guaranteed residual head on Heating side 2.5 m.c.a.

Protection Class IP54  
Electrical supply voltage 230 V  
Electrical supply frequency 50 Hz

The district heating substation is a fully pre-assembled, pre-cabled unit for heat transmission, featuring high yield and maximum operating safety. The structure consists of a zinc-plated frame covered with protective jackets in painted sheet metal which define the overall dimensions of the substation and houses:

- Braze welded **plate heat exchangers**
- **Safety accessories:**
  - Safety valves, ISPEL certified (PED)
  - Expansion tank
- **Monitoring accessories:**
  - Pressure gauges
  - Thermometers
  - High-sensitivity immersion sensors
- **Protection accessories:**
  - Safety thermostats
  - Safety dual thermostat for superheated water and single thermometer for hot water
- **Control accessories:**
  - Two-way seated poppet valves
  - Electrical servo control for the above-mentioned valves
- **Automatic control accessories:**
  - Thermal regulation station for monitoring temperatures at various points and programming and defining parameters for the physical and electrical values to be managed.
- **Main electrical control panel**

The wall-mounted district heating substations are available in two installation versions:

- wall-hung
- recessed

The wall-mounted district heating substations are available:

- for heating only
- for heating and DHW production

On request, the wall-mounted district heating substations can be supplied fully insulated, with a shell installed inside the frame.

## WALL-MOUNTED SUBSTATION FOR HEATING USE ONLY

This type of substation is suitable for **small capacity** systems supplied by **hot water** or **superheated water**. It is designed for **heating use only** (radiators, fan coils, floor panels, etc.) when production of domestic hot water is not required.

This type of substation is equipped with the TECHNO SYSTEM TSRE 010 temperature-control system.

With this type of substation, users can:

- directly set the heating set-point using easy-access dedicated pushbuttons.
- read the heating delivery temperatures directly on the controller display.
- manage heating independently, with separate onboard timers and weekly programs.
- manage heating by external thermostat/timer-thermostat or on the basis of a weekly schedule programmed in the controller (on/off settings at half-hour intervals).
- set SUMMER or WINTER parameters (heating deactivated in SUMMER mode).
- manage heating temperature by the fixed-point or climate-curve method.
- lock the heating-side set-point for systems serving floor panels.
- set an ANTI-SCUFF cycle for the HEATING side pump (if installed) when system is in SUMMER mode.
- set an ANTIFREEZE cycle with minimum threshold.
- maintain temperature in the primary circuit managed by the regulator (with times, intervals, and quantities set via the onboard calendar) or on request with by-pass through the ball valve.
- connect a safety thermostat on the heating side (for floor-panel systems) featuring cut-in signal (by acoustic alarm and display message).
- signal sensor malfunction (by acoustic alarm and display message). (TSRE 010)
- signal excessive pressure in the heating circuit by acoustic alarm and display message and signal low water level in the heating circuit (and shutdown of the heating side pump, if applicable) by acoustic alarm and display message.
- reset the values to factory defaults.
- integrate into other systems with accumulators, traditional boilers, and solar panels.

Additionally, this type of substation is prepared for installing devices for:

- limiting the flow rate on the DHS side.
- limiting the return temperature on the DHS side, with sensor malfunction signal (by acoustic alarm and display message).
- remote reading of the thermal energy meter.
- remote control.
- managing a GSM or PSTN modem connection, which permits sending SMSs or e-mails for notifying alarms or malfunctions.

### Capacities and Dimensions

Model	Heating Capacity (kW)	Overall dimensions (mm) Length x Height x Width	Connections on Primary Side	Connections on Heating Side	Empty Weight (kg)
<b>R34T</b>	34	580x685x220	G 1"	G 3/4"	20
<b>R50T</b>	50	580x685x220	G 1"	G 1"	28
<b>R75T</b>	75	760x765x275	G 1 1/4"	G 1 1/4"	60
<b>R100T</b>	100	760x765x275	G 1 1/4"	G 1 1/4"	61
<b>R116T</b>	116	760x765x275	G 1 1/4"	G 1 1/4"	62

**NOTE: the dimensions reported are purely indicative and refer to wall-hung substations constructed in accordance with TECHNO SYSTEM standards (dimensions may differ in the case of the recessed version).**

## Hydraulic Diagram

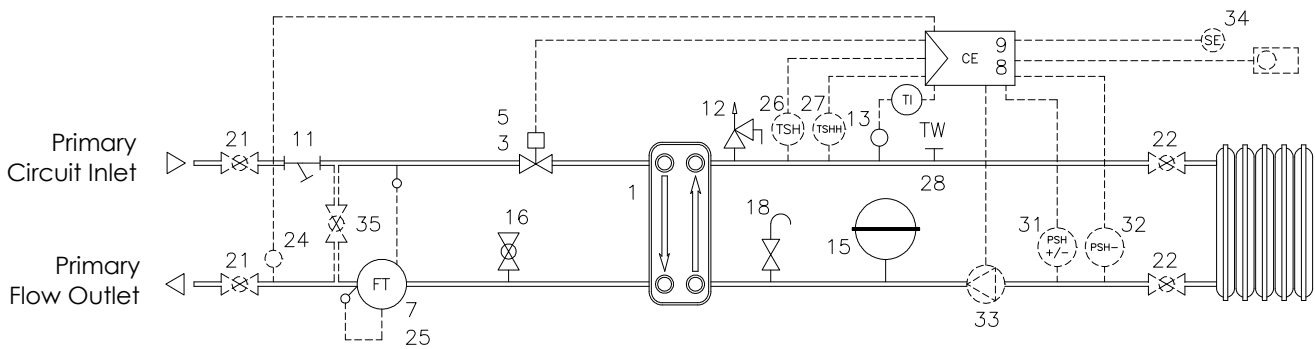

### COMPONENTS

- 1 Plate heat exchanger for HEATING
- 3 Servo-controlled valve for HEATING
- 5 Servomotor for HEATING
- 7 Thermal energy meter
- 8 Controller
- 9 Electrical panel
- 11 Filter
- 12 Safety valve
- 13 Temperature sensor on HEATING side
- 15 Expansion tank
- 16 Vent ball valve on PRIMARY side
- 18 Vent valve on HEATING side

### OPTIONALS

- ON/OFF VALVE SET**
- 21 On/off ball valve on PRIMARY side
- 22 On/off ball valve on HEATING side
- TEMPERATURE LIMITER SET PRIMARY SIDE**
- 24 Limit temperature sensor for PRIMARY side
- DELIVERY LIMITER SET PRIMARY SIDE**
- 25 Thermal energy meter with pulse counter card
- TEMPERATURE SAFETY SET HEATING SIDE FOR FLOOR PANEL SYSTEM**
- 26 Thermostat on HEATING side
- SUPERHEATED WATER**
- 27 Dual thermostat
- 28 ISPEL thermometer well
- PRESSURE SAFETY SET HEATING SIDE**
- 31 Maximum/Minimum pressure switch
- PUMP SET**
- 32 Minimum pressure switch
- 33 Circulation pump
- MISCELLANEOUS**
- 34 External sensor
- 35 Bypass ball valve

## **WALL-MOUNTED SUBSTATION FOR HEATING AND DOMESTIC HOT-WATER PRODUCTION (with heat exchangers in parallel configuration)**

This type of substation is suitable for **small capacity** systems, supplied by hot water (or superheated) for **heating** (via radiators, fan coils, floor panels, etc.) and **production of domestic hot water**.

This type of substation is recommended for systems requiring separate and independent management of the heating and domestic hot water circuits (the system may also be configured to give precedence to production of hot water over heating).

This type of substation is equipped with the TECHNO SYSTEM TSRE 010 temperature-control system.

With this type of substation, users can:

- directly set the heating set-point and the DHW set-point using easy-access dedicated pushbuttons.
- read the heating delivery, DHW, and recirculation (if applicable) temperatures directly on the controller display.
- manage heating and DHW production independently, with separate onboard timers and weekly programs.
- manage heating by external thermostat/timer-thermostat or on the basis of a weekly schedule programmed in the controller (on/off settings at half-hour intervals).
- set SUMMER or WINTER parameters (DHW only activated in SUMMER mode, DHW and heating activated in WINTER mode).
- manage heating temperature by the fixed-point or climate-curve method.
- set the set-points for heating, DHW, and recirculation (if applicable) independently.
- with the special Economy function, give precedence to DHW over HEATING.
- lock the heating-side set-point for systems serving floor panels.
- set an ANTI-SCUFF cycle for the HEATING side pump (if installed) when system is in SUMMER mode.
- set an ANTIFREEZE cycle with minimum threshold.
- maintain temperature in the primary circuit via bypass (with ball valve) or managed by the regulator (with times, intervals, and quantities set via the onboard calendar).
- connect a safety thermostat on the heating side (for floor-panel systems) featuring cut-in signal (by acoustic alarm and display message).
- connect a safety thermostat on the DHW side (for protection against scalding) featuring cut-in signal (by acoustic alarm and display message).
- signal sensor malfunction (by acoustic alarm and display message).
- signal excessive pressure in the heating circuit by acoustic alarm and display message and signal low water level in the heating circuit (and shutdown of the heating side pump, if applicable) by acoustic alarm and display message).
- reset the values to factory defaults.
- integrate into other systems with accumulators, traditional boilers, and solar panels.

Additionally, this type of substation is prepared for installing devices for:

- managing recirculation via PID with set-point independent of DHW.
- managing an ANTI-LEGIONELLA thermal disinfection cycle via onboard calendar (the system must comprise recirculation).
- limiting the flow rate on the DHS side.
- limiting the return temperature on the DHS side, with sensor malfunction signal (by acoustic alarm and display message).
- remote reading of the thermal energy meter.
- remote control.
- managing a GSM or PSTN modem connection, which permits sending SMSs or e-mails for notifying alarms or malfunctions.

### **Capacities and Dimensions**

Model	Heating Capacity (kW)	Overall dimensions (mm) Length x Height x Width	Connections on Primary Side	Connections on Heating Side	Connections on DHW Side	Empty Weight (kg)
<b>RI34T.P</b>	34+34	580x685x220	G 1"	G 3/4"	G 1/2"	30
<b>RI50T.P</b>	50+34	760x765x275	G 1 1/4"	G 1"	G 1/2"	45

**NOTE: the dimensions reported are purely indicative and refer to wall-hung substations constructed in accordance with TECHNO SYSTEM standards (dimensions may differ in the case of the recessed version).**

## Hydraulic Diagram

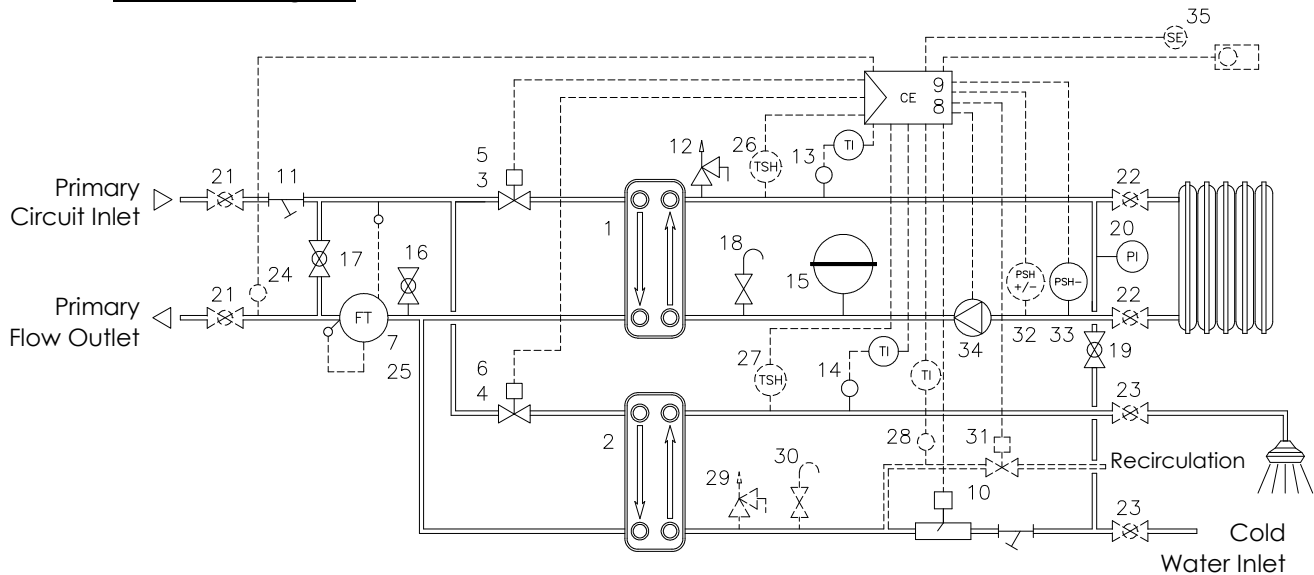

### COMPONENTS

- 1 Plate heat exchanger for HEATING
- 2 Plate heat exchanger for DHW
- 3 Servo-controlled valve for HEATING
- 4 Servo-controlled valve for DHW
- 5 Servomotor for HEATING
- 6 Servomotor for DHW
- 7 Thermal energy meter
- 8 Controller
- 9 Electrical panel
- 10 Flow switch
- 11 Filter
- 12 Safety valve
- 13 Temperature sensor on HEATING side
- 14 Temperature sensor on DHW side
- 15 Expansion tank
- 16 Vent ball valve on PRIMARY side
- 17 Bypass ball valve
- 18 Vent valve on HEATING side
- 19 Filling ball valve
- 20 Pressure gauge
- 33 Minimum pressure switch
- 34 Circulation pump

### OPTIONALS

- ON/OFF VALVE SET**
- 21 On/off ball valve on PRIMARY side
  - 22 On/off ball valve on HEATING side
  - 23 On/off ball valve on DHW side
- TEMPERATURE LIMITER SET PRIMARY SIDE**
- 24 Limit temperature sensor for PRIMARY side
- DELIVERY LIMITER SET PRIMARY SIDE**
- 25 Thermal energy meter with pulse counter card
- TEMPERATURE SAFETY SET HEATING SIDE FOR FLOOR PANEL SYSTEM**
- 26 Thermostat on HEATING side
- TEMPERATURE SAFETY SET DHW SIDE (ANTI-SCALDING)**
- 27 Thermostat on DHW side
- RECIRCULATION SET**
- 28 Temperature sensor on RECIRCULATION side
  - 29 Safety valve on DHW side
  - 30 Vent valve on DHW side
  - 31 On/off ball valve on RECIRCULATION side
- PRESSURE SAFETY SET HEATING SIDE**
- 32 Maximum/Minimum pressure switch
- MISCELLANEOUS**
- 35 External sensor

## **WALL-MOUNTED SUBSTATION FOR HEATING AND DOMESTIC HOT WATER PRODUCTION (with heat exchangers in series configuration)**

This type of substation is suitable for **small capacity** systems supplied by **superheated water** (or by hot water at sufficiently high temperature). It is designed for **heating** (via radiators, fan coils, floor panels, etc.) and **production of domestic hot water**.

This type of substation is recommended for systems in which independent management of the heating and domestic hot water circuits is not required (hot water production always takes precedence over heating).

This type of substation is equipped with the TECHNO SYSTEM TSRE 010 temperature-control system.

With this type of substation, users can:

- directly set the heating set-point using easy-access dedicated pushbuttons.
- read the heating delivery, DHW, and recirculation (if applicable) temperatures directly on the controller display.
- manage heating and DHW production independently, with separate onboard timers and weekly programs.
- manage heating by external thermostat/timer-thermostat or on the basis of a weekly schedule programmed in the controller (on/off settings at half-hour intervals).
- set SUMMER or WINTER parameters (DHW only activated in SUMMER mode, DHW and heating activated in WINTER mode).
- manage heating temperature by the fixed-point or climate-curve method.
- set the set-points for heating, DHW, and recirculation (if applicable) independently.
- lock the heating-side set-point for systems serving floor panels.
- set an ANTI-SCUFF cycle for the HEATING side pump (if installed) when system is in SUMMER mode.
- set an ANTIFREEZE cycle with minimum threshold.
- maintain temperature in the primary circuit managed by the regulator (with times, intervals, and quantities set via the onboard calendar) or on request with by-pass through the ball valve.
- connect a safety thermostat on the heating side (for floor-panel systems) featuring cut-in signal (by acoustic alarm and display message).
- connect a safety thermostat on the DHW side (for protection against scalding) featuring cut-in signal (by acoustic alarm and display message).
- signal sensor malfunction (by acoustic alarm and display message).
- signal excessive pressure in the heating circuit by acoustic alarm and display message and signal low water level in the heating circuit (and shutdown of the heating side pump, if applicable) by acoustic alarm and display message).
- reset the values to factory defaults.
- integrate into other systems with accumulators, traditional boilers, and solar panels.

Additionally, this type of substation is prepared for installing devices for:

- managing recirculation via PID with set-point independent of DHW.
- managing an ANTI-LEGIONELLA thermal disinfection cycle via onboard calendar (the system must comprise recirculation).
- limiting the flow rate on the DHS side.
- limiting the return temperature on the DHS side, with sensor malfunction signal (by acoustic alarm and display message).
- remote reading of the thermal energy meter.
- managing remote control.
- managing a GSM or PSTN modem connection, which permits sending SMSs or e-mails for notifying alarms or malfunctions.

### **Capacities and Dimensions**

Model	Heating Capacity (kW)	Overall dimensions (mm) Length x Height x Width	Connections on Primary Side	Connections on Heating Side	Connections on DHW Side	Empty Weight (kg)
<b>RI34T.S</b>	34	580x685x220	G 3/4"	G 3/4"	G 1/2"	32

**NOTE: the dimensions reported are purely indicative and refer to wall-hung substations constructed in accordance with TECHNO SYSTEM standards (dimensions may differ in the case of the recessed version).**



## Hydraulic Diagram

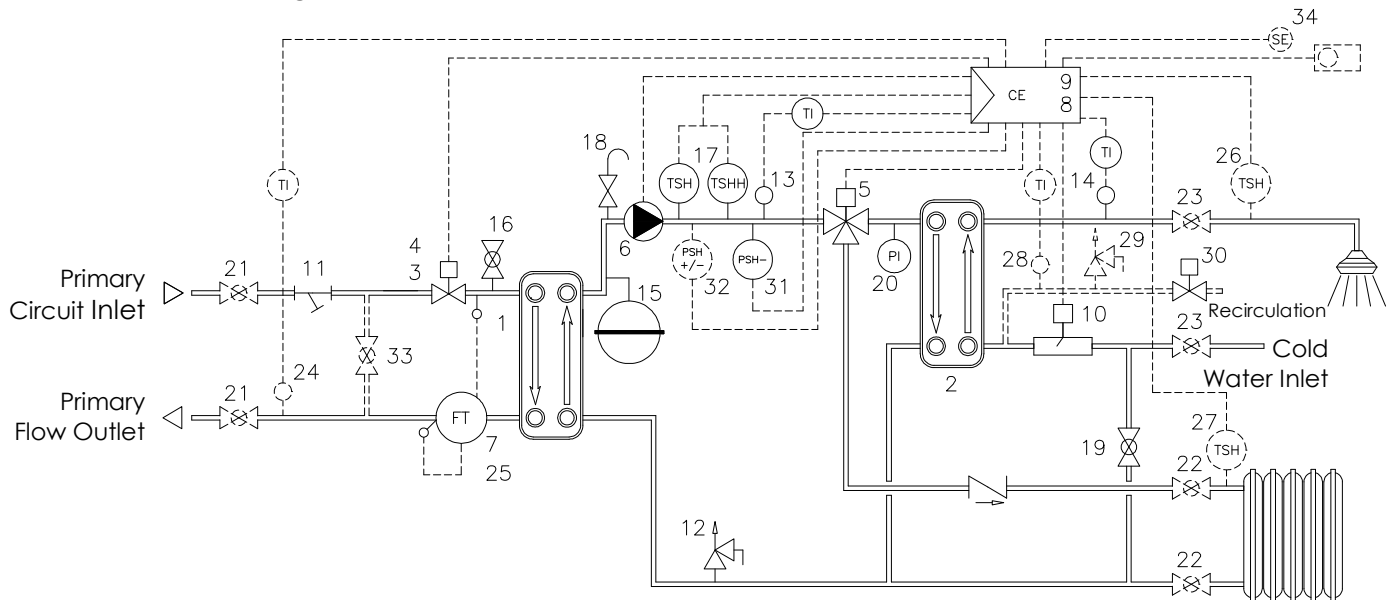

### COMPONENTS

- 1 Interface plate heat exchanger
- 2 Plate heat exchanger for DHW
- 3 Servo-controlled valve
- 4 Servomotor
- 5 3-way valve
- 6 Circulation pump
- 7 Thermal energy meter
- 8 Controller
- 9 Electrical panel
- 10 Flow switch
- 11 Filter
- 12 Safety valve
- 13 Temperature sensor on HEATING side
- 14 Temperature sensor on DHW side
- 15 Expansion tank
- 16 Vent ball valve on PRIMARY side
- 17 Dual thermostat
- 18 Vent valve on HEATING side
- 19 Filling ball valve
- 20 Pressure gauge
- 31 Minimum pressure switch











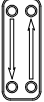









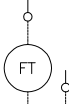















### OPTIONALS

- ON/OFF VALVE SET**
- 21 On/off ball valve on PRIMARY side
  - 22 On/off ball valve on HEATING side
  - 23 On/off ball valve on DHW side
- TEMPERATURE LIMITER SET, PRIMARY SIDE**
- 24 Limit temperature sensor for PRIMARY side
- DELIVERY LIMITER SET, PRIMARY SIDE**
- 25 Thermal energy meter with pulse counter card
- TEMPERATURE SAFETY SET HEATING SIDE FOR FLOOR PANEL SYSTEM**
- 26 Thermostat on HEATING side
- TEMPERATURE SAFETY SET DHW SIDE (ANTI-SCALDING)**
- 27 Thermostat on DHW side
- RECIRCULATION SET**
- 28 Temperature sensor on RECIRCULATION side
  - 29 Safety valve on DHW side
  - 30 On/off valve on DHW side
- PRESSURE SAFETY SET HEATING SIDE**
- 32 Maximum/Minimum pressure switch
- MISCELLANEOUS**
- 33 Bypass ball valve
  - 34 External sensor

# EXAMPLES OF SYSTEM LAYOUTS

## LEGEND

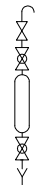
The symbols shown and explained in this section refer to the system layout diagrams reproduced below. Although these diagrams have been modified according to the needs of the designer, they are all highly reliable and thoroughly "field-tested."

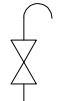
	Heat exchanger		Ball valve		ISPEL thermometer well
	Radiator		Butterfly valve		Expansion tank
	Hot domestic water outlet		Safety valve		Electrical panel
	Accumulation tank		Thermal energy meter		Logic unit (not supplied)
	Boiler		Flow switch		Non-return valve
	Solar panel		External sensor		Water-softening unit
	Pool		Room thermostat		Pressure reducer
	2-way valve		Temperature-control thermostat		Bypass valve
	3-way valve		Maximum pressure switch		Water treatment
	3-way mixing valve		Minimum pressure switch		Pool filter
	Circulation pump		Thermometer		Pump with pre-filter
	Y filter		Pressure gauge		Hydraulic separator
	Sensor		Vent valve		

## DIAGRAM No. 1

**Skid-type substation for heating use only with integrated TS module for instantaneous domestic hot water production**

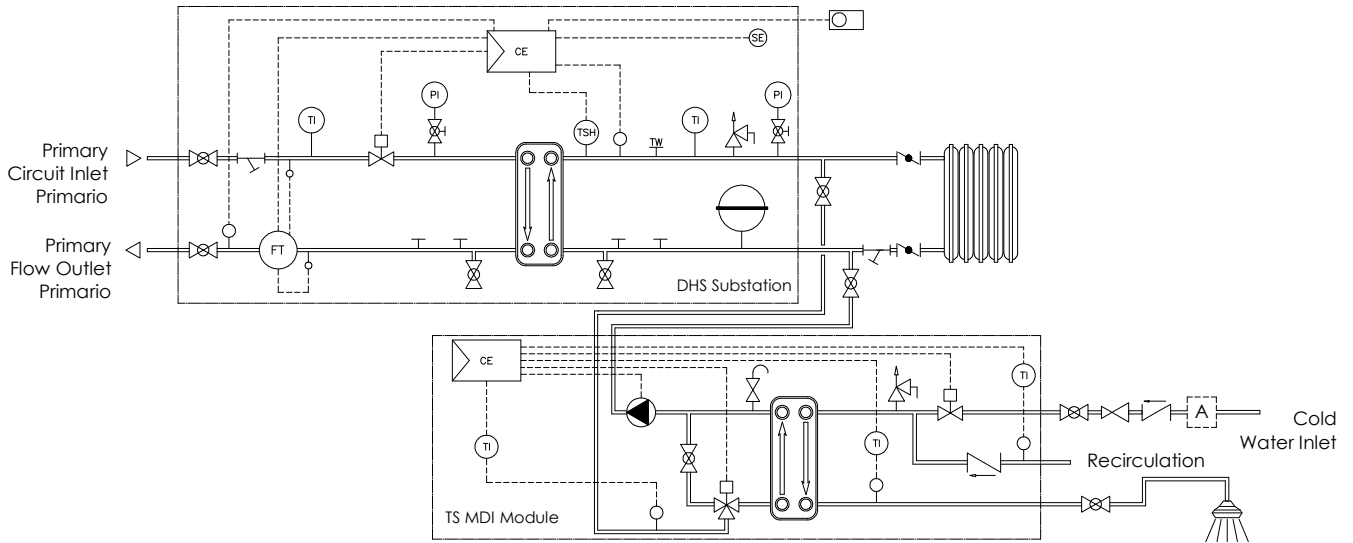

## DIAGRAM No. 2

**Skid-type substation for heating use only with integrated TS Module for use with accumulation tank for domestic hot water production**

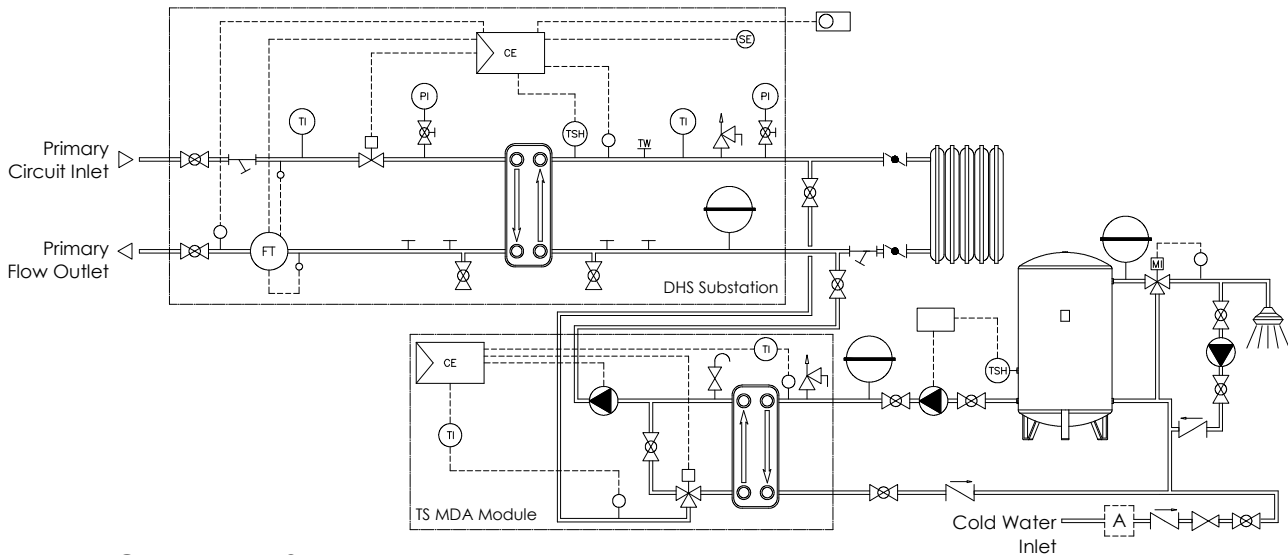

## DIAGRAM No. 3

**Skid-type substation for heating use only with integrated TS Module for pool heating**

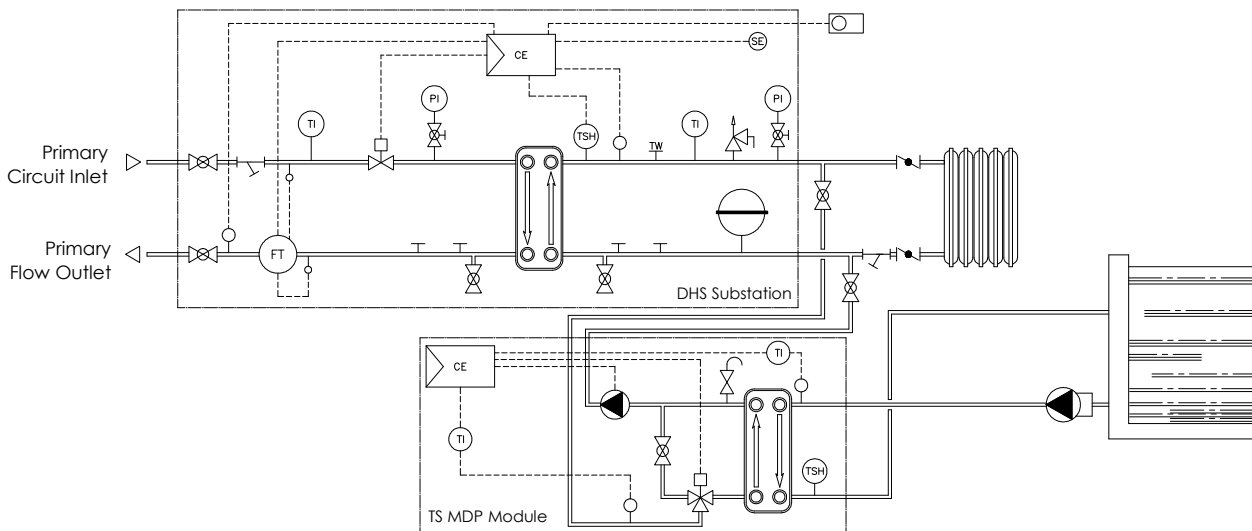

## DIAGRAM No. 4

### Skid-type or wall-mounted substation for heating use only with integrated boiler for domestic hot water production

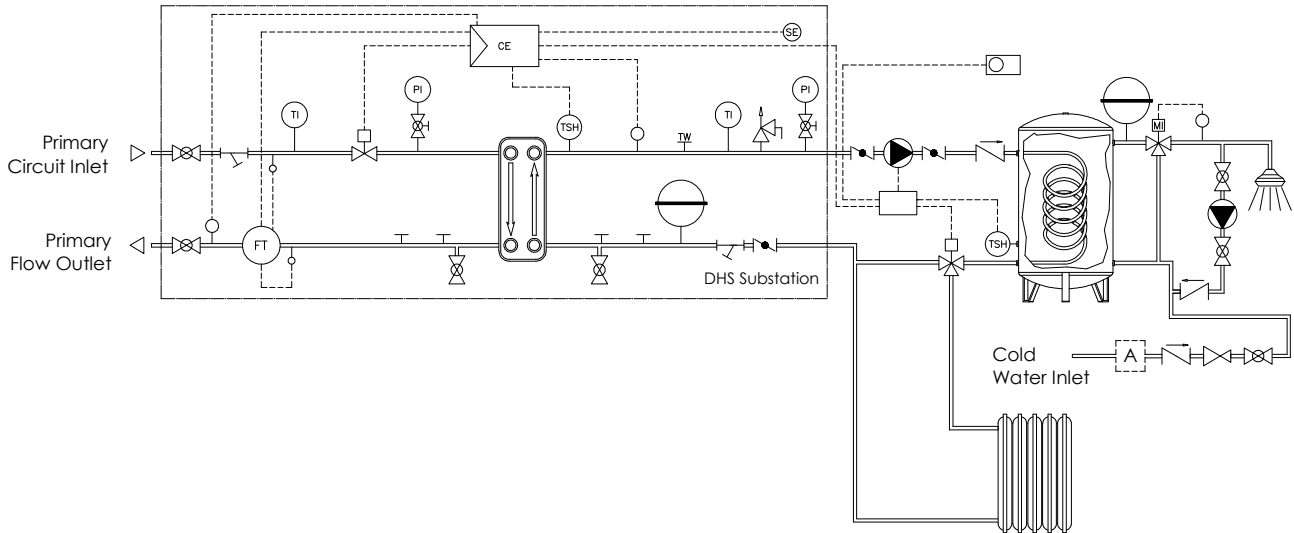

Warning: in case of system installation employing wall-mounted substation, the heating side pump should not be supplied (or is supplied, should not be connected to the controller on the substation but, instead, to a logic unit external to the substation).

## DIAGRAM No. 5

### Wall-mounted substation with heat exchangers in parallel configuration and integrated accumulation tank

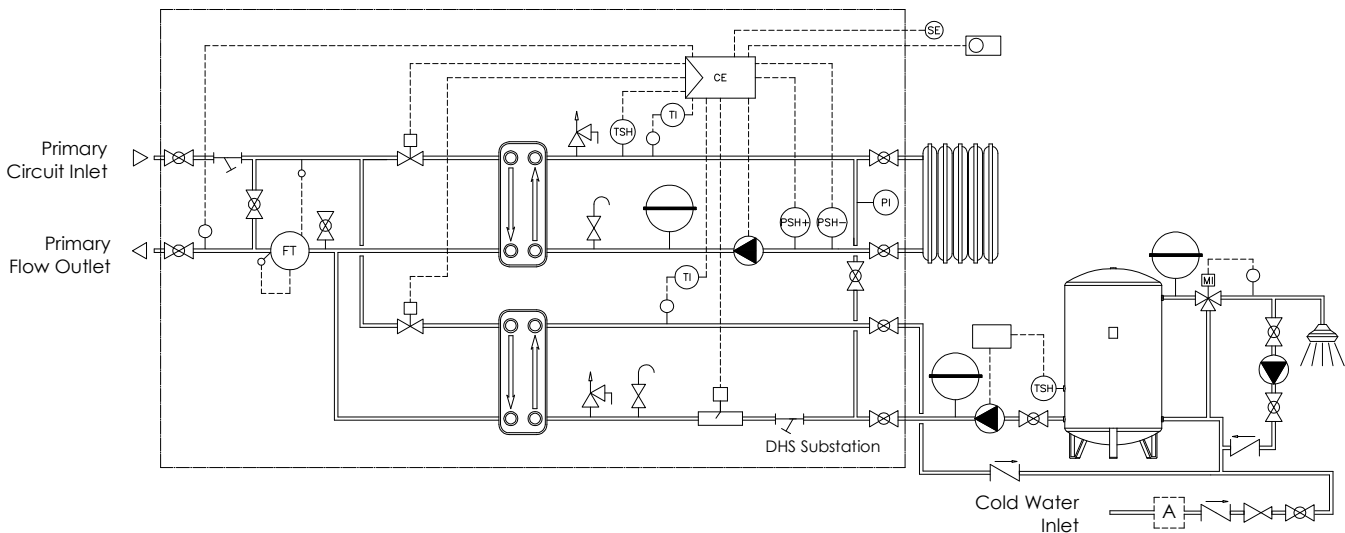

## DIAGRAM No. 6

### Wall-mounted substation with heat exchangers in parallel configuration and integrated accumulators and solar panels

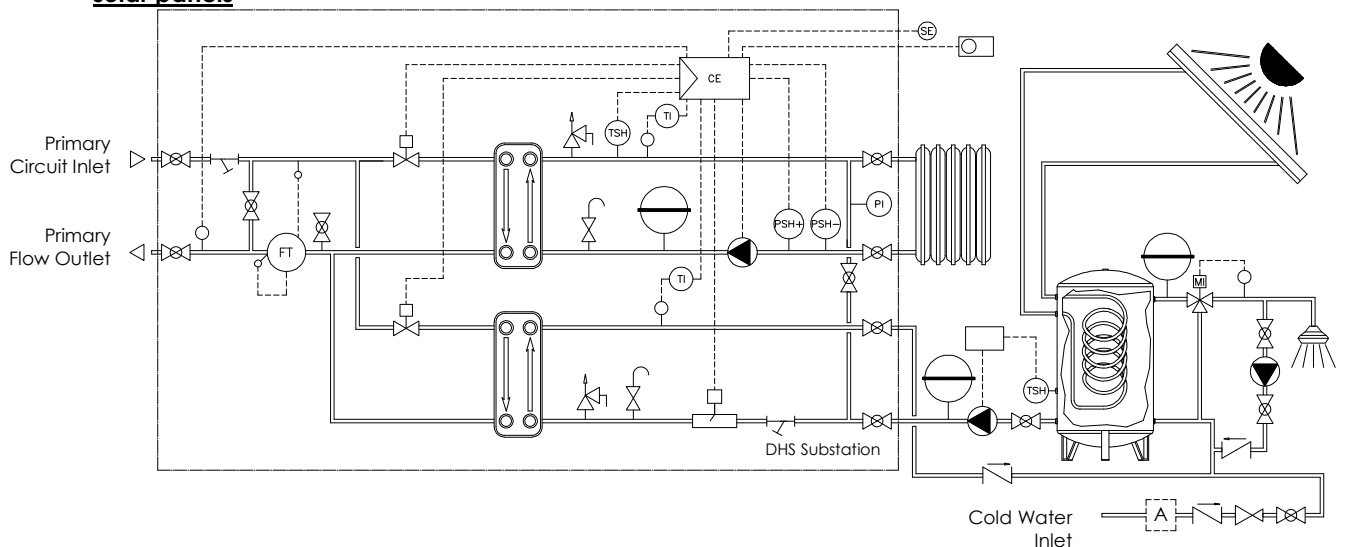

# DIAGRAM No. 7

## Wall-mounted substation with parallel exchangers and hydraulic separator on heating circuit

